



LANDY MANUFACTURING

OPERATOR MANUAL

Skid Steer Trencher

Model: S-TCR910(36IN)-MP1220

RB: TCR36



www.landymfg.com

sales@landymfg.com

General

For us, the long lifecycle and efficiency of your new equipment is a priority. To keep the Trencher in top working condition, read this manual carefully before using the equipment.

Never let anyone operate or maintain the device without reading this manual carefully! Always make sure that safety precautions are observed in use and maintenance. Keep this manual for future reference and make sure to hand it over to a new owner.

The cornerstones of the product development of LANDY attachments are quality, durability and economy. The products are engineered to be high-performing, safe and durable in professional use. Any feedback on our products is welcome and contributes to the further development of our products. If you have any questions about the use or maintenance of the Trencher, please contact us by e-mail: sales@landymfg.com

The manufacturer reserves the right for structural and technical changes without prior notice. Therefore, some pieces of information given in the manual may have changed after printing this manual.

Read before use

Make sure you know your equipment before you start using it.

Equipment may be operated only by an individual who is thoroughly familiar with its use.

All operators must be properly instructed before use and maintenance of the equipment. Use by individuals with insufficient instructions may pose serious risks to the operators themselves, to the environment and the equipment.

When coupling the attachment to the base machine, make sure:

- that all locking cotters are intact and in order
- there is no pressure in the hydraulic system
- that hydraulic hoses are intact
- there is no skin contact to hydraulic oil when connecting hydraulic hoses
- not to pull by the hydraulic hoses, but only by the hydraulic fitting

During operation, pay attention to:

- safe, appropriate travel speed
- other traffic, people and animals
- danger zones and objects that block your view
- children

NEVER use the machine, if there is someone in the danger zone.

NEVER go under the attachment.

Check all bolts, nuts and hydraulic fittings for tightness after the first day of operation!

If the equipment is not likely to be used for a longer period of time, clean it thoroughly after use and lubricate as instructed.

Table of contents

1. PURPOSE OF USE	3
2. SAFETY PRECAUTIONS	3
3. INFORMATION OF THE TRENCHER	4
4. USING THE TRENCHER.....	4
5. OPERATING THE TRENCHER	5
6. MAINTENANCE OF THE TRENCHER.....	6

1. PURPOSE OF USE

Mini Loader trencher features an adjustable depth control foot which ensures the operator trenches at a set depth at all times.

2. SAFETY PRECAUTIONS

Make sure you know your equipment before you start using it. Equipment may be operated only by an individual who is thoroughly familiar with its use.

Before connecting hydraulics to the base machine, make sure that:

- there is no-one between the attachment and the base machine
- the base machine is turned off and the parking brake is on.

When coupling the attachment to the base machine, make sure that:

- all locking cotters are intact and in order
- hydraulic hoses are intact
- there is no skin contact to hydraulic oil when connecting hydraulic hoses
- you do not to pull by the hydraulic hoses, but only by the hydraulic fitting.

During operation, pay attention to:

- safe, appropriate travel speed
- other traffic, people and animals
- danger zones and objects that block your view
- children
- use of turn signal when driving

NEVER use the machine, if there is someone in the danger zone

NEVER go under the attachment

During maintenance, the hydraulics of the base machine MUST be turned off. The base machine MUST also be turned off and the parking brake MUST be applied. The equipment must be properly supported, if maintenance can only be performed by going under the equipment. Never go under the equipment if it is not properly supported.

Daily maintenance:

- check general condition of structures, make repairs if needed
- check the hydraulic hoses and fittings, and replace damaged parts

After every 50 hours of operation:

- lubricate points specified in later section of this manual
- check all bolts and nuts for tightness

WARNING! Pressurized hydraulic hoses and components!

3. INFORMATION OF THE TRENCHER

Unit: mm

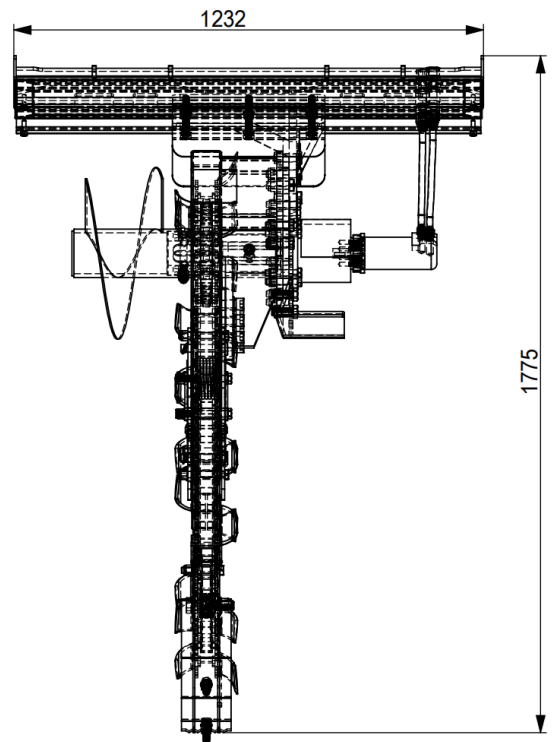
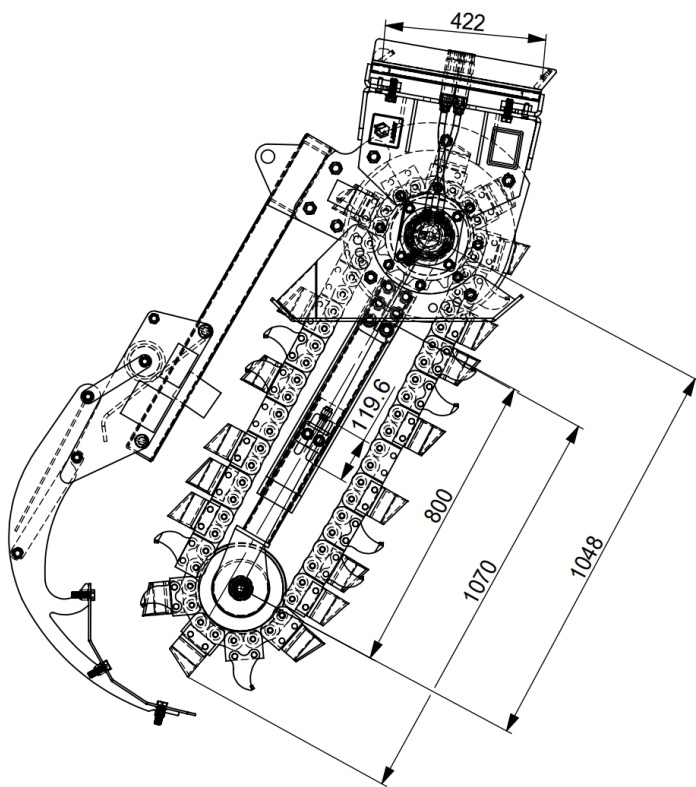

Weld on Mount Plate:

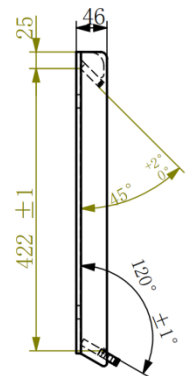
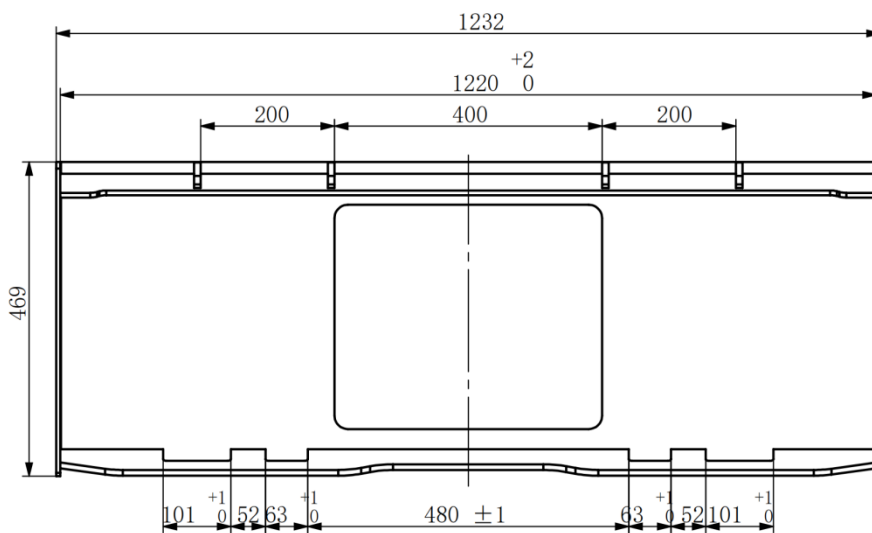

4. USING THE TRENCHER

When attaching the Trencher for the first time, make sure it is compatible with the base machine by following the instructions below. Always check the compatibility when attaching the collecting sweeper to a new base machine.

4.1. Attaching the Trencher to the base machine

The Trencher is attached to the base machine by welded or bolted quick hitches. The machine is connected to connected to a hydraulic system.

Before using the Trencher, MAKE SURE all locking cotters are secured and intact.

When coupling Trencher to the base machine, please pay attention to the instructions on the use of the base machine.

1. Make sure that the attachment and the base machine are compatible in terms of mechanical solutions, hydraulics and electricity.
2. Apply parking brake. The Trencher is attached to the coupler on the base machine. Attach the Trencher to the base machine, and make sure the locking cotter are secured.
3. Turn off the base machine and make sure the parking brake is applied.
4. Make sure there is no pressure in the base machine hydraulic system. When connecting, always make sure the hydraulic connectors are clean and the hoses are intact.
5. Check carefully the attachment's, the base machine's and the fitting's trajectory for collision. Make sure that the needed space for hydraulic hoses and -attachments is adequate. Check that the brush roll rotates outwards from the. If not, switch hoses in the base machine.
6. During first hours of operating the attachment, bolts, nuts and connectors might loosen up. Retighten them after the first day of operating the attachment.

5. OPERATING THE TRENCHER

Check following before using the Trencher:

- Trencher is installed properly to the base machine
- All locking cotters are in place
- Hydraulic hoses are attached properly
- Hoses are intact
- There are no oil leaks in attachment
- All functions are in order
- Learn the functions of the Trencher in an enclosed area before actual usage.
- Observe all unusual activity and oil leaks when operating the Trencher.

5.1. Using the Trencher

1. Make sure that the attachment and the base machine are compatible in terms of mechanical solutions, hydraulics and electricity.
2. Apply parking brake. The Trencher is attached to the coupler on the base machine. Attach the Trencher to the base machine, and make sure the locking cotters are secured.
3. Turn off the base machine and make sure the parking brake is applied.
4. Make sure there is no pressure in the base machine hydraulic system. When connecting, always make sure the hydraulic connectors are clean and the hoses are intact.
5. Check carefully the attachment's, the base machine's and the fitting's trajectory for collision. Make sure that the needed space for hydraulic hoses and -attachments is adequate. Check that the brush roll rotates outwards from the. If not, switch hoses in the base machine.
6. Lift Trencher front and back support legs. Lock them in upward position with locking cotters.
7. Keep the Trencher in suitable distance from ground. The attachment could be damaged!

8. Stay alert for any abnormal behaviour and oil leaks also during driving.

5.2. Detaching the Trencher from the base machine

1. Turn off the base machine, apply the parking brake and depressurize the system.
2. Detach the hydraulic hoses and protect hose ends with plugs.
3. Unlock the coupling mechanism and detach the device.
4. If the equipment is not likely to be used for a longer period of time, clean it thoroughly after operating and lubricate as instructed. Remove water from irrigation system's hoses. If possible, store the unit inside.

6. MAINTENANCE OF THE TRENCHER

6.1 General safety precautions for the use and maintenance

- Comply with existing laws and regulations and the instructions given in this manual.
- Never go under an unsecured device.
- Always apply the parking brake of the base machine before performing any actions on the device.
- Only use tools that are in proper working order.
- Be careful with the pressurized hydraulic hoses and components.
- Make sure there is no pressure in the hydraulic system. Take into account the pressure accumulator.
- Make sure hydraulic fluids or greases do not leak to the ground.
- Use all necessary personal protectors.

6.2. Daily maintenance

In order to prevent further damages, it is important to inspect the device visually for possible defects. Inspect at least the following daily:

- hydraulic hoses and components for possible leaks
- general mechanical functioning

6.3. Maintenance after first 10 hours of operation

- Lubricate, preferably with a grease or equivalent.
- Check all bolts and nuts for tightness.

6.4. Maintenance at 50-working hour intervals or on a weekly basis

- Lubricate, preferably with a grease or equivalent.
- Check the mechanical condition of the device for bends, distortions or breaches
- Check fastening bolts for tightness.